

COMPANY PROFILE



Visit Our Website
Website: psvglobal.com





**POLYGON SYNERGY
VENTURES**

Background

Incorporated in 2019 Polygon Synergy Ventures SDN BHD (PSV) is a Malaysian company based in Puncak Alam, Selangor.

Expertise: Specializes in custom-made teaching and research equipment fabrication and trading.

Reputation: Known for reliable supply sources and a strong customer base.

Skilled Team: Includes salespeople, engineers, specialists, and technologists.

Services: Offers Core Analysis for major Oil and Gas companies, along with maintenance, calibration, 3rd party lab services, consultancy, and more.





Company Vision

To become the first Malaysian public-listed company specializing in innovative laboratory solutions by the year 2028.



**POLYGON SYNERGY
VENTURES**

Company Mission

Mission For Employee: To help everyone to achieve financial freedom.

Mission For Customers: To provide innovative and cost-effective solutions to clients.

Mission For Product: To provide innovative and advanced engineering solutions.

Mission For Society: To help to build a better society.

Mission For Country: To contribute to the economy's growth.



Visit Our Website
Website: psvglobal.com



POLYGON SYNERGY
VENTURES

Team



MARINAH YAAKOP

Founder/
Managing Director

- **17+ years in business leadership**
- **Expertise in growth & operations management**
- **Guides company direction & executive teams**



M. RIDUAN AHMAD

Founder/
General Manager

- **17+ years as General Manager**
- **Specializes in lab operations & team leadership**
- **Focus on strategic management for efficiency & growth**



AMIRUDIN MOHAMAD

Operation Manager

- **21+ years as operations manager**
- **Specializes in workflow optimization**
- **Ensures seamless daily operations across sectors**



DINESH KUMAR

Business Development
Manager

- **19+ years in oil & gas**
- **Lead business development & client relationships**
- **Expertise in growth & strategic initiatives**



SHARIFAH DALINA

Human Resource Manager

- **17+ years in HR management**
- **Talent acquisition and employee relations**
- **HR policies and labor law compliance**



PSV ORGANIZATION CHART 2024/25

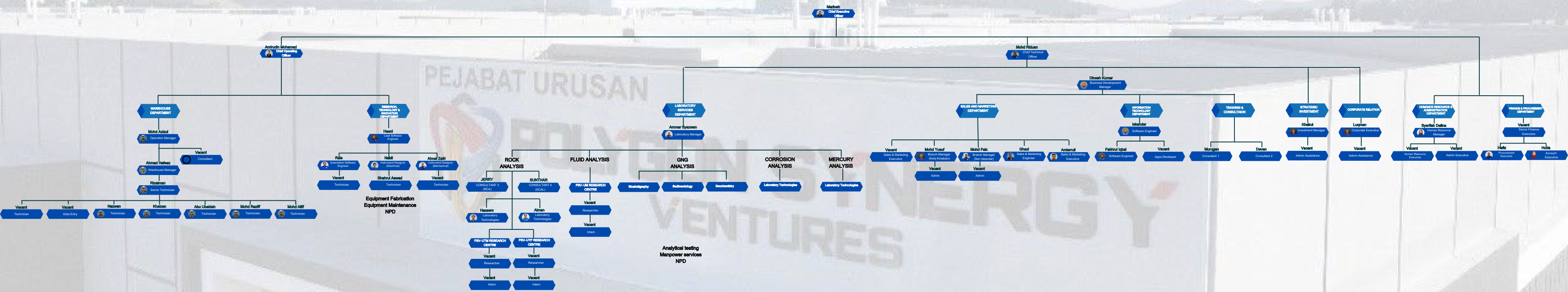

ONE INDUSTRY ALL SOLUTION



**POLYGON SYNERGY
VENTURES**

Our Journey



2014

- July 19 Polygon Synergy Ventures (PSV) SDN BHD was established
- Registered with PETRONAS to supply products/services to PETRONAS and its subsidiaries.



2020

Expand the number of staff and start hiring internship
Branch in Seri Iskandar



2022

Polygon Scientific Resources started with an enterprise company that provides small custom-made equipment fabrication and parts supplier core sample distributor

2019



- Expand the range of service
- Provide manpower to operate core flooding equipment and analysis
- Provide manpower for onsite core preservation

2021



To have our own, Malaysia's first SCAL lab that liaised with ISO 17025 Following standard practice for quality management system (ISO 9001:2015)

ONE INDUSTRY ALL SOLUTION



5 YEARS PLANNING

POLYGON SYNERGY VENTURES

- Lab Capabilities 20-30%
- Baseline parameter capabilities
- Standard Operation Procedure (SOP)
- Strengthen team
- ISO 9000 (Establishment)
- New product development, Poroperm, Coreflood
- Lab Services for the education sector

- Establish Corrosion, SCAL & Fluid laboratory
- ISO 17025 accreditation
- ISO 14001 accreditation (Environmental & Safety)
- 5 New product release (NPD)
- Sarawak establishment
- Established Polygon Research Center (PRC)
- New revenue stream
 - Software development
 - Automation system
 - Petroleum warehouse services
 - Smartlab – centralize analytical platform

- Establishment of Polygon Group Of Company:
 - PSV- Laboratory services
 - Offshore services
 - Drone application
 - Technical Training Consultant
 - Cleaning Services





2025 ROADMAP

POLYGON SYNERGY VENTURES

FEB 2025

- Launch new Equipment-Coreflood
- Completion of Syringe Pump
- Implementation (Sieve Analysis)
- NPD 1-Viton Sleeve ready

April 2025

- Smartlab system launch
- Corrosion monitoring services
- Explore Thailand market

JUNE 2025

- Explore Indonesian Market opportunities
- NPD 2-HPLC Pump ready

AUG 2025

- Tank Cleaning
- NPD 3-Gas booster pump ready

DEC 2025

- NPD 5-Capri system
- Annual Dinner

OCT 2025

- NPD 4-Core centrifuge

NOV 2025

- ISO 17025 accreditation

Q1

AGM

Town Hall

Town Hall

Town Hall

Annual Dinner

JAN 2025

- Launching of RCA & SCAL
- Training Program
- G&G Lab Launching
- Acquire more Petronas SWEC
- R&D Center PSV-UTM & PSV-UM
- Opening PSV Sarawak

MARCH 2025

- Cleaning Equipment
- Drying Equipment
- Slabbing Unit RCA
- PSV Warehouse services
- IPTC exhibition

MAY 2025

- Kazakhstan Coreflood Delivery & commissioning
- Establish Fluid laboratory

Q3

JULY 2025

- Exhibition Sabah
- Exhibition Sarawak

SEPT 2025

- Explore Kazakhstan Market
- Acquire additional certification ISO 14001 (Environmental & Safety)

Q4

ONE INDUSTRY ALL SOLUTION



POLYGON SYNERGY
VENTURES

LOCATION



ONE INDUSTRY ALL SOLUTION



GLOBAL MARKET

POLYGON SYNERGY VENTURES

SELANGOR, HQ



PERAK, BRANCH



PSV LOCATION

- SELANGOR, HQ
- PERAK, BRANCH
- PGSC, BRANCH
- SABAH, BRANCH

FUTURE EXPANSION

- INDONESIA (2025)
- THAILAND (2025)
- KAZAKHSTAN (2025)

ATLANTIC OCEAN

PACIFIC OCEAN

SABAH, BRANCH

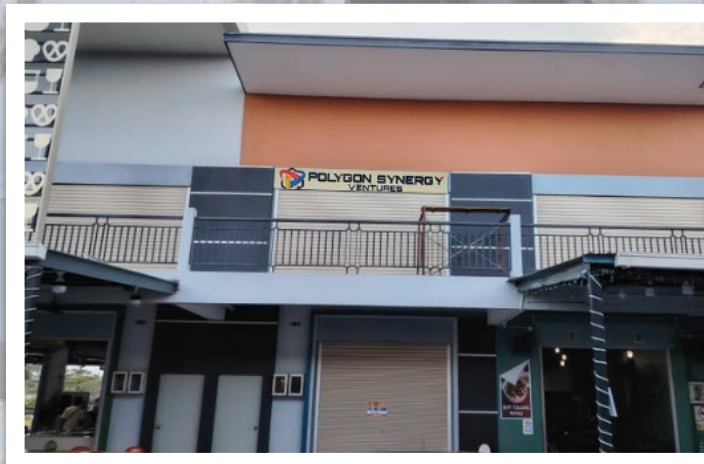

PGSC, BRANCH



INDIAN OCEAN

ONE INDUSTRY ALL SOLUTION



10 BUSINESS SEGMENT



EQUIPMENT FABRICATION



ANALYTICAL TESTING



EQUIPMENT MAINTENANCE, SERVICING & CALIBRATION



TRADING & SUPPLIES



GEO SAMPLE WAREHOUSE SERVICES



MANPOWER SERVICES



TRAINING & CONSULTATION



AUTOMATION SYSTEM

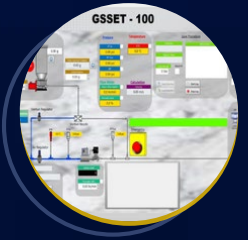

SOFTWARE DEVELOPMENT



WAREHOUSE SERVICES

YOU ARE MORE STRONGER THAN YOU THINK!
 CREATE YOUR OWN FUTURE
IM POSSIBLE IS...
NO THING
 NEVER GIVE UP!
 BREAK YOUR FEARNESSE
 You can do anything with faith, determination and hard work in your impossible dreams.
 WHATEVER YOU DO DO IT WITH PASSION





Visit Our Website

Website: psvglobal.com

OUR SKILLS & CAPABILITIES



**POLYGON SYNERGY
VENTURES**

AREA OF EXPERTISE



POLYGON SYNERGY
VENTURES



1. EQUIPMENT FABRICATION

Customize Equipment



Rare Earth Element Extraction Equipment



Rock Mechanics Equipment



Carbon Captured Storage & Utilization



HPHT RCA, SCAL & PVT Equipment



Flow Loop System



Our Website
Website: psvglobal.com

AREA OF EXPERTISE



POLYGON SYNERGY
VENTURES



2. ANALYTICAL TESTING

Special Core analysis



GNG Analysis



Rock Mechanic Analysis



Fluid Analysis



PVT Analysis



Corrosion Analysis



AREA OF EXPERTISE



3. EQUIPMENT MAINTENANCE, SERVICING & CALIBRATION

Equipment Refurbishment



Sensor calibration



Equipment Servicing



Preventive Maintenance



Equipment Training



AREA OF EXPERTISE



4. TRADING & SUPPLIES

HPHT Tubing & Gas Piping



Laboratory General Apparatus



Consumables



Gas & Chemical Reactor



Flow Loop System



Petroleum Rock Samples



AREA OF EXPERTISE



5. GEO SAMPLE WAREHOUSE SERVICES

Handling & Preparation



Repackaging & Re-boxing



Sample Logistic Management



Cold Room Storage



AREA OF EXPERTISE



6. MANPOWER SERVICES

Laboratory Analytical Testing



High Pressure High Temperature Equipment

Handling



Core Preservation & Offshore Services



Equipment Migration



AREA OF EXPERTISE



7. TRAINING & CONSULTATION

10+ Internal Subject Matter Expert (SME)



30+ years of experience in industry



**Custom training & design to the client's
requirement**



Visit Our Website
Website: psvglobal.com

AREA OF EXPERTISE



8. AUTOMATION SYSTEM

SCADA System Development



HMI Design & Implementation



PLC Programming & Troubleshooting



Control Panel Design & Installation



Sensor Calibration & Integration



System Integration



Visit Our Website
Website: psvglobal.com

AREA OF EXPERTISE



9. SOFTWARE DEVELOPMENT

Custom Software Development



Web Development



Software Integration Services



Mobile App Development



Enterprise Software Solutions



Visit Our Website
Website: psvglobal.com

AREA OF EXPERTISE



10. WAREHOUSE SERVICES

Storage and Inventory Management



Logistics and Distribution



Specialized Handling Services



Visit Our Website
Website: psvglobal.com



**POLYGON SYNERGY
VENTURES**

OUR PRODUCT

- Polygon Synergy Ventures Sdn Bhd



**BUATAN MALAYSIA
MADE IN MALAYSIA**

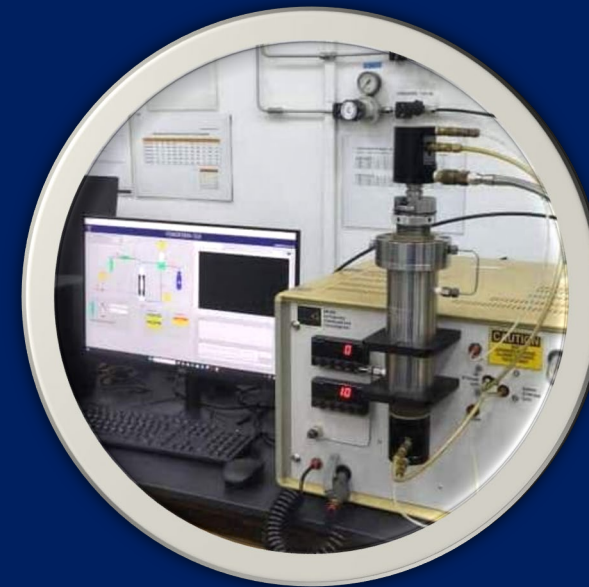
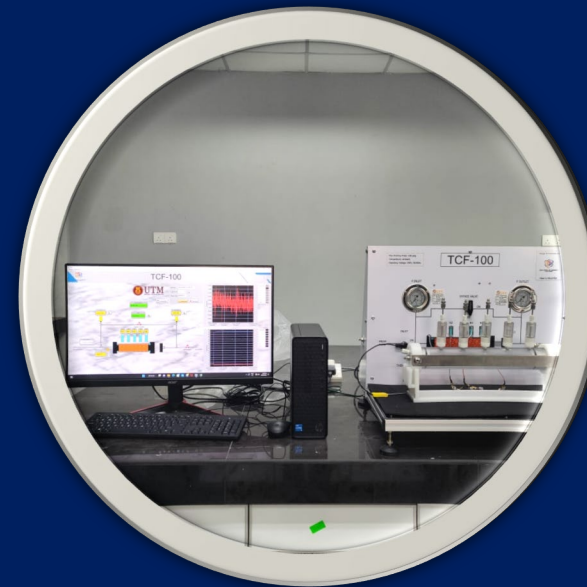



POLYGON SYNERGY
VENTURES

DESIGN, MODELING & SOFTWARE DEVELOPMENT

Design

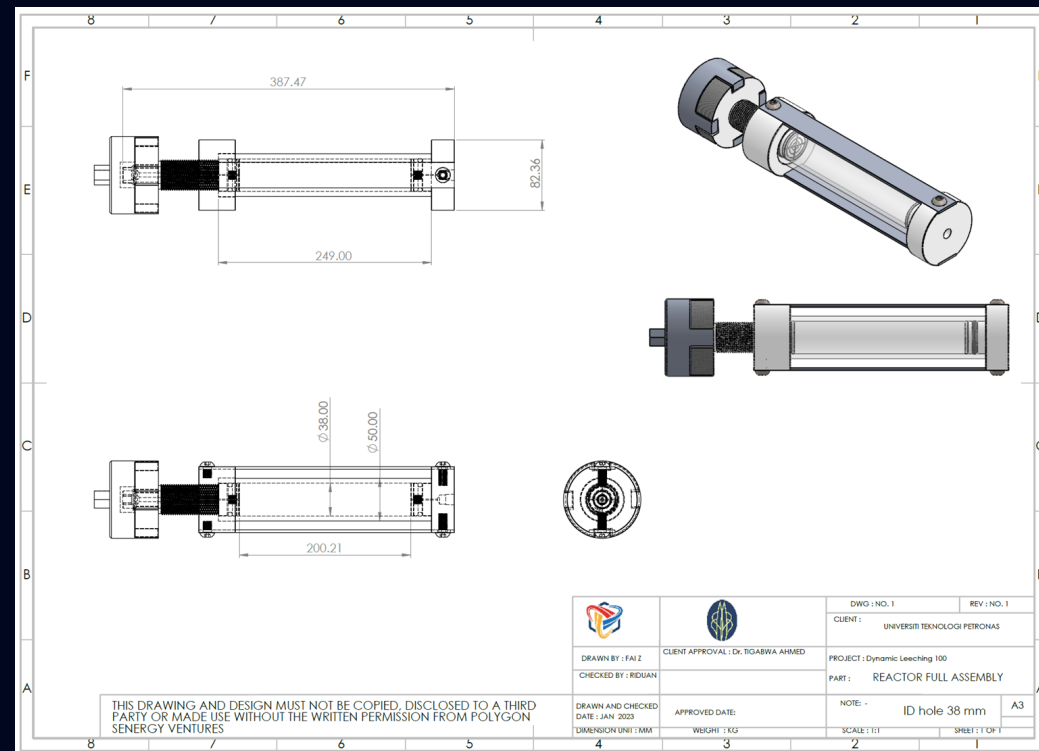

Client: UTP, Seri Iskandar
Equipment:
Sandpac Core Holder

Modeling

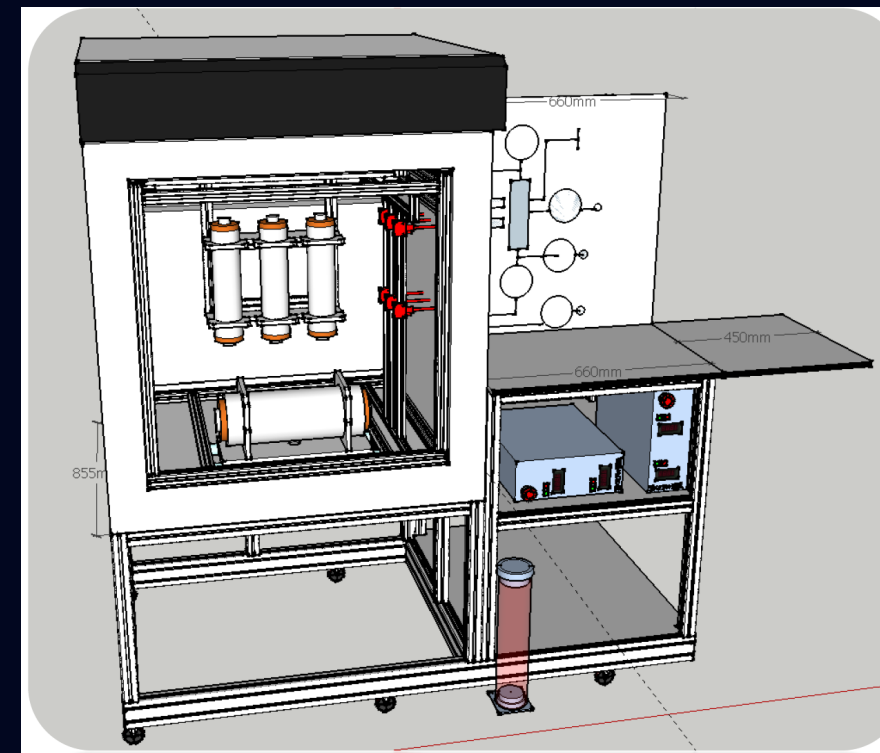

Client : UTP, Seri Iskandar
Equipment:
Basic Coreflood System (BCFS-350)

Software Development

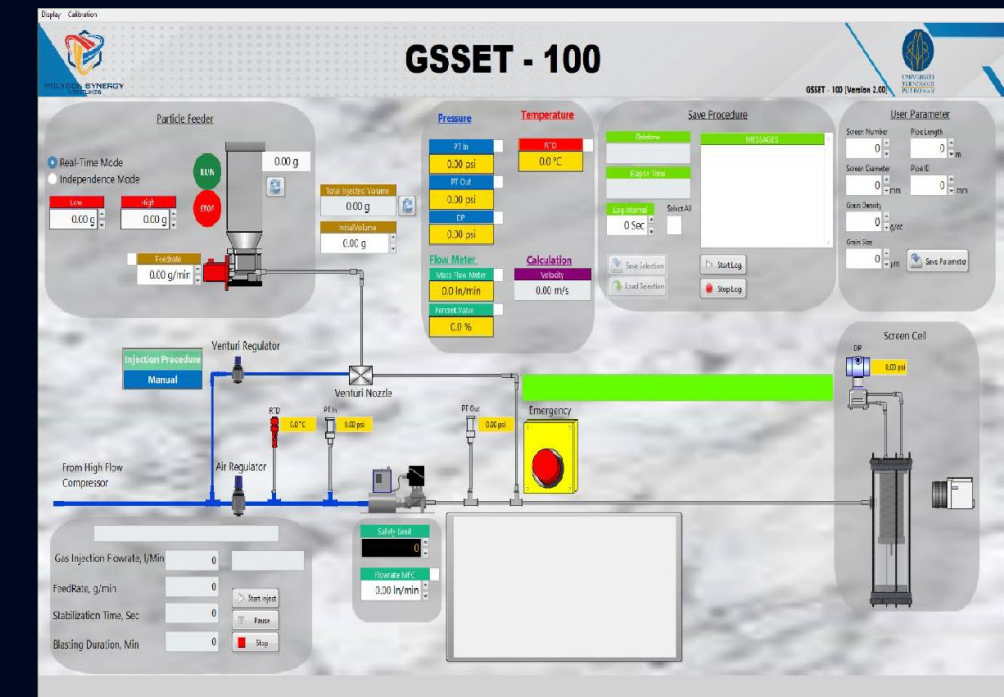

Client : UTP, Seri Iskandar
Equipment:
Gas Sand Screen Erosion Test (GSSET-100)



**POLYGON SYNERGY
VENTURES**

EQUIPMENT MAINTENANCE

PCRI 250



Client: UiTM, Shah Alam
Equipment:
**Basic Capillary Pressure &
Resistivity Index (PCRI 250)**

SRT 350



Client : UTP, Seri Iskandar
Equipment:
**Sand Retention Test Equipment
(SRT 350)**

BCFS 350



Client : UTP, Seri Iskandar
Equipment:
**Basic Core Flooding
System (BCFS 350)**



**POLYGON SYNERGY
VENTURES**

EQUIPMENT MAINTENANCE

TCF-20



Client: UiTM, Shah Alam
Equipment: Teaching Core Flood
(TCF 20)

Liner Opener



Client ONYX Engineering, Selangor
Equipment: Liner Opener

LPS 5000



Client : ONYX Engineering, Selangor
Equipment: LPS 5000



**POLYGON SYNERGY
VENTURES**

EQUIPMENT MAINTENANCE

IES-100



**Client: UTP, PERAK
Equipment:
Ion Exchange Setup
(IES-100)**

DLS-100



**Client UTP, PERAK
Equipment:
Dynamic Leaching Test
(DLS-100)**

TCF-100

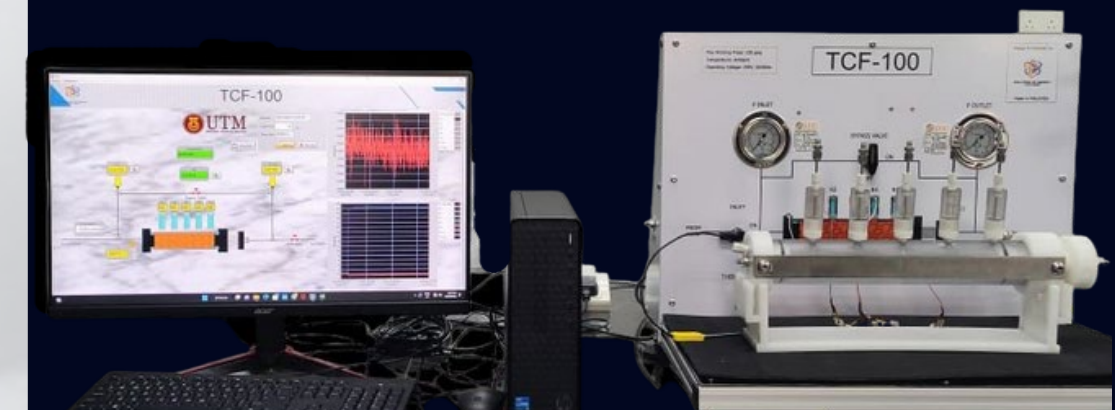

**Client : UTM, JOHOR
Equipment:
Teaching Coreflood
(TCF-100)**



**POLYGON SYNERGY
VENTURES**

EQUIPMENT MAINTENANCE

GSSET-100

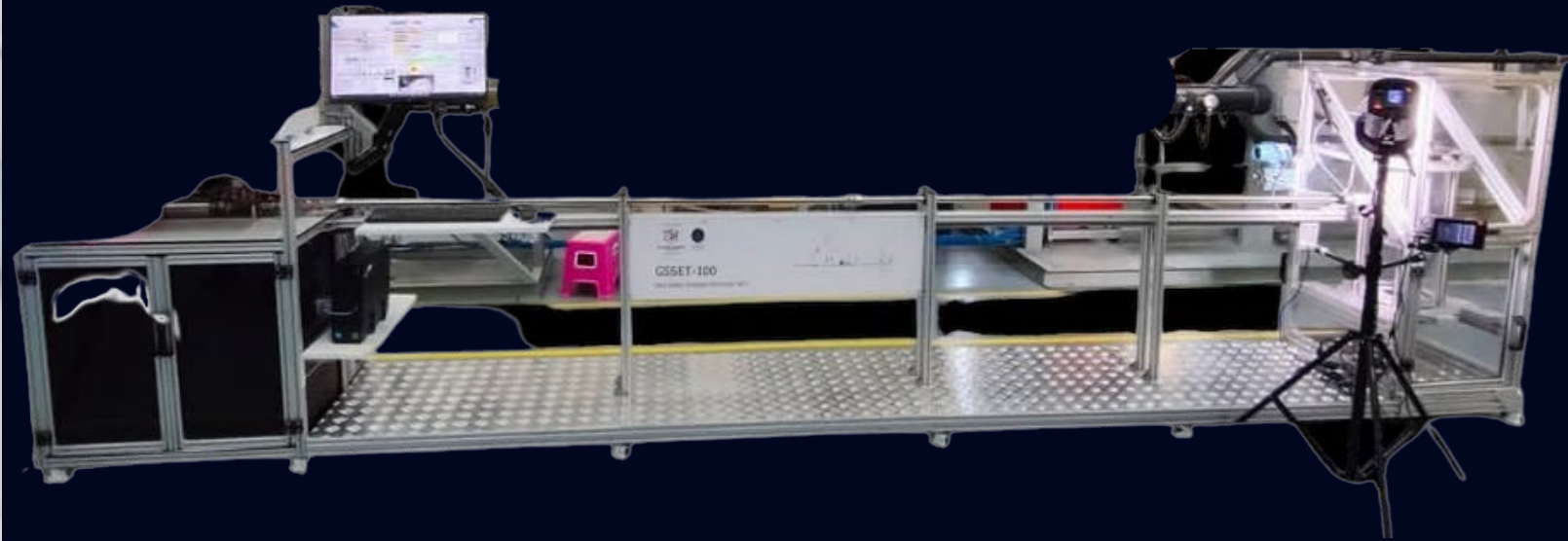

Client: UTP, PERAK
Equipment:
Gas Sand Screen Erosion Test
(GSSET-100)

CDT-350



Client: UTP, PERAK
Equipment:
Constant Drawdown Test
(CDT-350)



**POLYGON SYNERGY
VENTURES**

EQUIPMENT MAINTENANCE

RO Membrane



Client: UTP, PERAK
Equipment:
RO Membrane

PR-100



Client: UTP, PERAK
Equipment:
Solid Liquid Separator
(PR-100)



**POLYGON SYNERGY
VENTURES**

EQUIPMENT MAINTENANCE

FLUIDIZED & FIXED BED REACTOR



Client: UKM-MTJA

Equipment:

Fluidized & Fixed Bed Reactor for producing CO, H₂ & CH₄



POLYGON SYNERGY
VENTURES

EQUIPMENT MAINTENANCE

CLIENT A.P UNIVERSITY



TP1219

Equipment:
Helium Porosimeter (Coretest)



TKA-209

Equipment:
Gas Permeameter (Coretest)



TEP-231

Equipment:
Electrical Properties (Coretest)



POLYGON SYNERGY
VENTURES

EQUIPMENT MAINTENANCE

CAPRI System



Client: PETRONAS Research
SDN BHD
Equipment:
CAPRI System by DCI Test System

PVT Fluid Evaluation



Client UTP, Perak
Equipment:
PVT Equipment

ELECTROMAGNETIC VISCOMETER



Client : UTP, Perak



POLYGON SYNERGY
VENTURES

EQUIPMENT MAINTENANCE

CLIENT: UTP PERAK



HTHP DENSITOMETER



FLOWLOOP APPARATUS

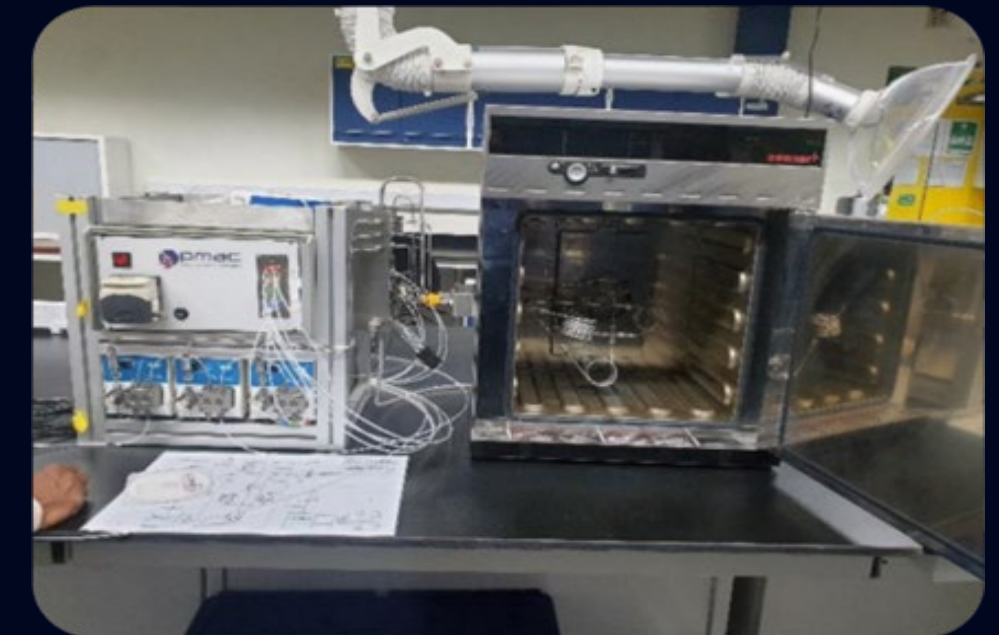

DYNAMIC SCALE LOOP



TRADING & SUPPLIES

POLYGON SYNERGY
VENTURES

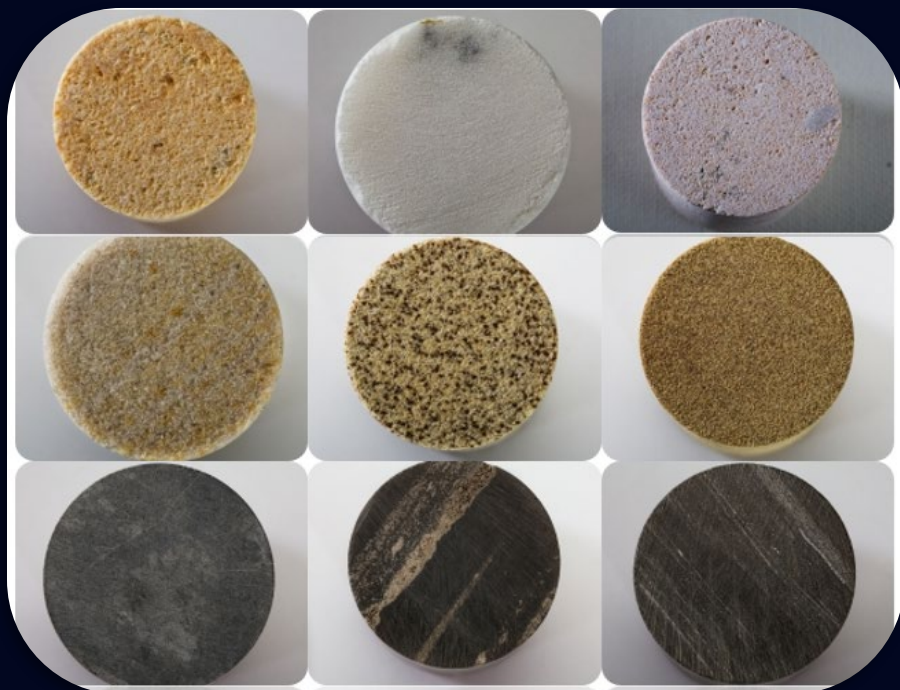

Sandstone, Carbonate, Shale

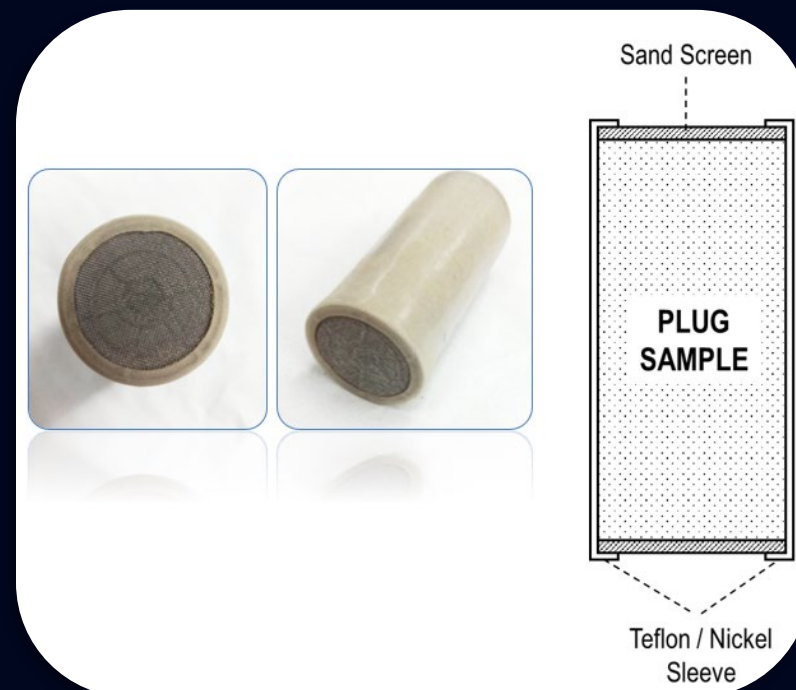

Costume Sand pack



Multi-layer Perm Samples

2024 New Product Release



Coreflooding Equipment

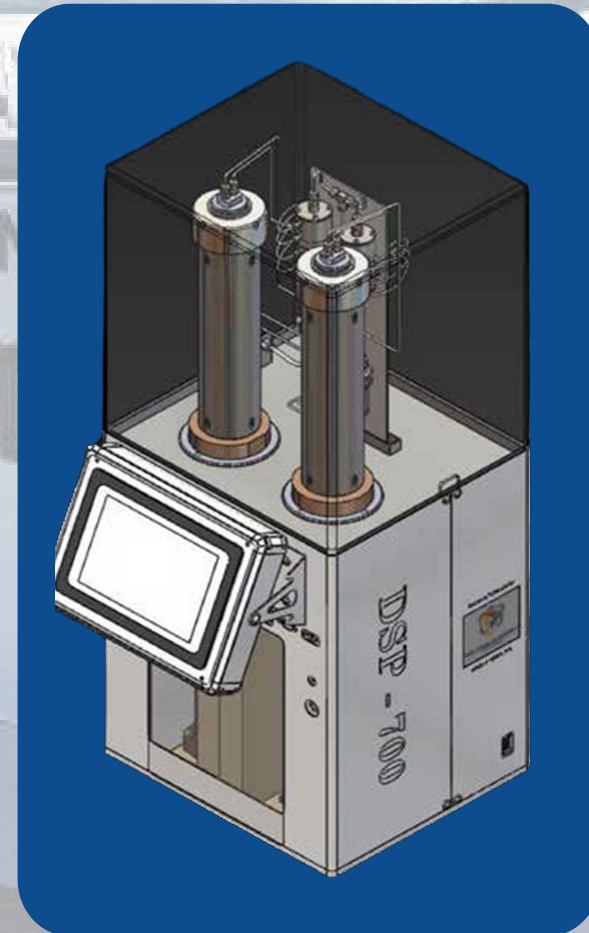

Syringe Pump

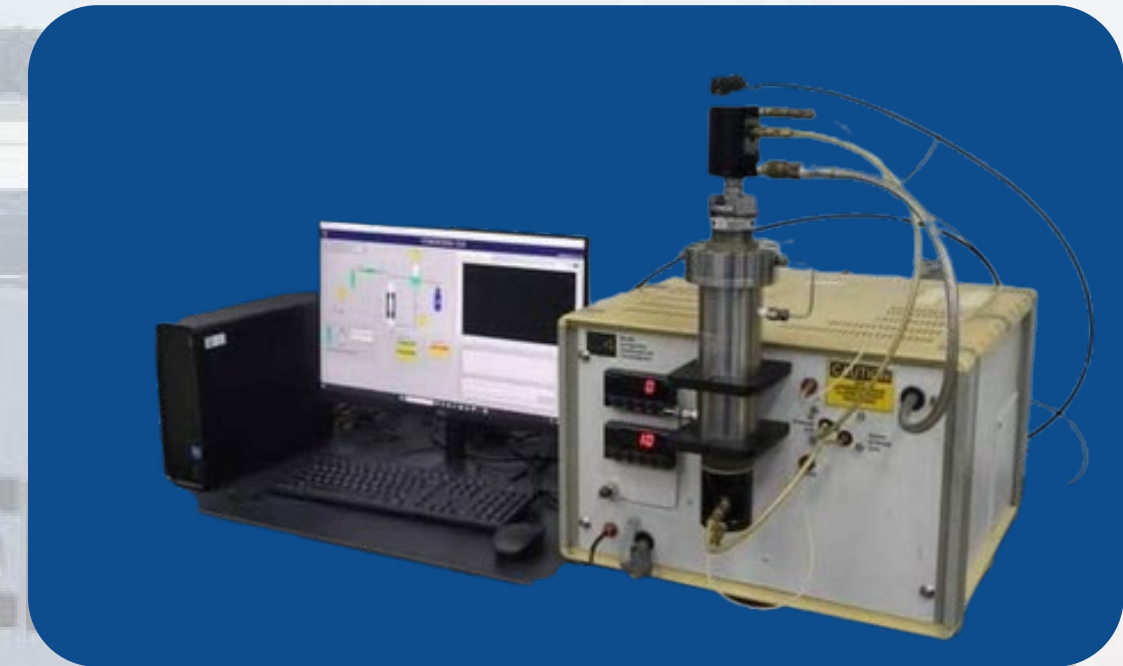

Poroperm



OUR CLIENTS & COLLABORATORS



ONE INDUSTRY ALL SOLUTION



OUR CLIENTS & COLLABORATORS



UPM
UNIVERSITI PUTRA MALAYSIA
BERILMU BERBAKTI



UTM
UNIVERSITI TEKNOLOGI MALAYSIA



UTP
UNIVERSITI TEKNOLOGI PETRONAS



UNIVERSITI
TEKNOLOGI
MARA



USM

UNIVERSITI SAINS MALAYSIA



اوتیورسیتی ملیسیا فوہج السلطان عبد اللہ
UNIVERSITI MALAYSIA PAHANG
AL-SULTAN ABDULLAH



UNIVERSITY
OF MALAYA



A.P.U.
ASIA PACIFIC UNIVERSITY
OF TECHNOLOGY & INNOVATION



UNIVERSITI
KEBANGSAAN
MALAYSIA
The National University
of Malaysia



مجلسین آف اے اے مریٹے



UNIVERSITI
MALAYSIA
PERLIS



Curtin University
Malaysia

UNIVERSITI
TENAGA
NASIONAL



ONE INDUSTRY ALL SOLUTION



COMPANY RECOGNITION

POLYGON SYNERGY VENTURES

PREFERRED VENDOR FOR STRAIGHT 4 YEARS FROM UTP 2020 - 2023

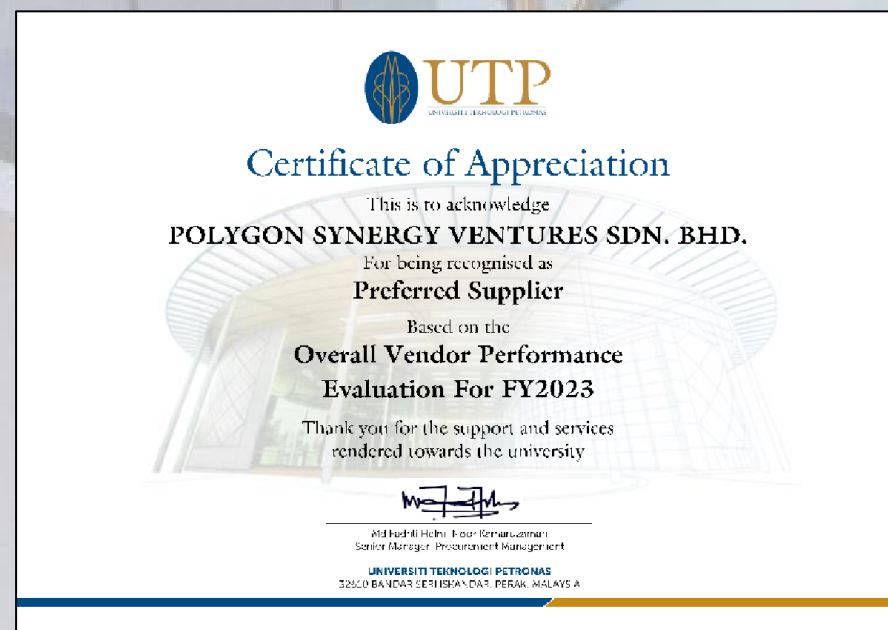
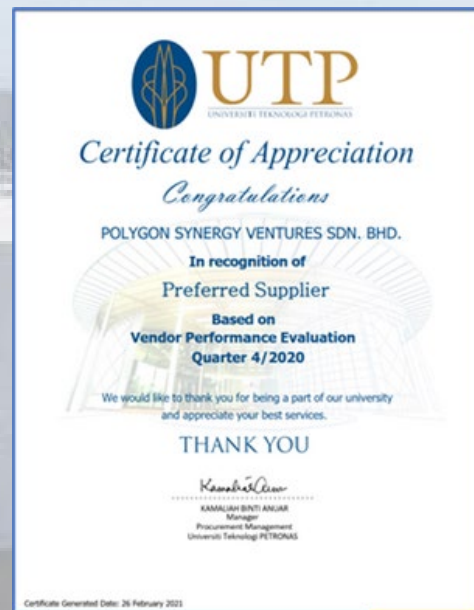

QUALITY MANAGEMENT SYSTEM 9001:2015



ISO 9001:2015

ONE INDUSTRY ALL SOLUTION



POLYGON SYNERGY VENTURES



POLYGON SYNERGY VENTURES

COMPANY CERTIFICATE



KEMENTERIAN KEWANGAN MALAYSIA SIJIL AKUAN PENDAFTARAN SYARIKAT

NO. SIJIL : K10102881593255045
NO. RUJUKAN PENDAFTARAN : 357-0002348721
TEMPOH SAH LAKU : 21/06/2022 - 20/06/2025

Bahawa dengan ini diperakui syarikat :

POLYGON SYNERGY VENTURES SDN. BHD. (1332248-V)
NO. 39, JALAN ECO PERINDUSTRIAN 1/3C
ECO PERINDUSTRIAN 5
KUALA SELANGOR
42300 BANDAR PUNCAK ALAM
SELANGOR, MALAYSIA

Telah berdaftar dengan Kementerian Kewangan Malaysia dalam bidang bekalan/perkhidmatan di bawah sektor, bidang dan sub-bidang seperti di Lampiran A. Kelulusan ini adalah tertakluk kepada syarat-syarat seperti yang dinyatakan di Lampiran B. Individu yang diberi kuasa oleh syarikat bagi urusan perolehan Kerajaan adalah seperti berikut :

ENCIK MOHD RIDUAN BIN AHMAD 860227387669 PENGARAH URUSAN
PUAN MARDIAH BINTI YAAKOP 890708085466 MANAGER ADMIN

LI

AB RAHIM BIN AB RAHMAN
Bahagian Perolehan Kerajaan
b.p. Ketua Setiausaha Perbendaharaan
Kementerian Kewangan Malaysia

Tarikh Berdaftar Dengan Kementerian Kewangan Malaysia : 21/06/2022

(Sijil ini adalah cetakan komputer dan tidak memerlukan tandatangan)

MOF LICENSE



KEMENTERIAN KEWANGAN MALAYSIA

SIJIL AKUAN PENDAFTARAN SYARIKAT BUMIPUTERA

NO. SIJIL : BP10102881593744983
NO. RUJUKAN PENDAFTARAN : 357-0002348721
TEMPOH SAH LAKU : 29/02/2024 - 20/06/2025

Bahawa dengan ini diperakui syarikat :

POLYGON SYNERGY VENTURES SDN. BHD. (1332248-V)
NO. 39, JALAN ECO PERINDUSTRIAN 1/3C
ECO PERINDUSTRIAN 5
KUALA SELANGOR
42300 BANDAR PUNCAK ALAM
SELANGOR, MALAYSIA

Telah dikira sebagai Syarikat Bumiputera oleh Kementerian Kewangan Malaysia. Taraf Bumiputera bukannya hak dan boleh ditarik balik sekiranya syarikat gagal mematuhi syarat/kriteria yang ditetapkan. Kelulusan ini adalah tertakluk kepada syarat-syarat seperti yang dinyatakan di Sijil Akuan Pendaftaran Syarikat Bumiputera (Lampiran C).

LI

DATO' INDERA AB RAHIM BIN AB RAHMAN
Perbendaharaan Malaysia Semenanjung
b.p. Ketua Setiausaha Perbendaharaan
Kementerian Kewangan Malaysia

Tarikh Berdaftar Dengan Kementerian Kewangan Malaysia : 21/06/2022

(Sijil ini adalah cetakan komputer dan tidak memerlukan tandatangan)

BUMIPUTERA LICENSE



PETRONAS

LICENSE TO SUPPLY PRODUCT/SERVICE TO EXPLORATION AND OIL/GAS COMPANIES IN MALAYSIA

In exercising the powers conferred by Section 7, Petroleum Development Act 1974 and in accordance with Regulation 3 of the Petroleum Regulations 1974, delegated to me by the Prime Minister of Malaysia, I hereby issue the license under Regulation 3 of the Petroleum Regulations for the purpose of the above to:

Certificate generated at 29/12/2023

POLYGON SYNERGY VENTURES SDN. BHD. (1332248-V)
NO. 39, JALAN PPS 3, PUSAT PERDAGANGAN SELAKARAH BATU CAVE, SELANGOR.

Details of License are as follows:

Company's No : 2019032919
Type of Company : License
Duration of License : 21/06/2022 - 06/06/2025
License Fee : RM 750.00
Categories of Product/Service : As attached to 'CATEGORIES OF LICENSE / REGISTRATION'

Special Conditions imposed onto this License:

Subject to the special conditions as attached.

General requirements of this License are as stated in the next page.

Renewal License that Apply for Renewal 4 Months Before The Expiry Date.

PETRONAS LICENSE GENERAL CONDITIONS

- Company is required to register, obtain a license, permit or authorization from the relevant authority to carry out the service or supply of product or material used in company's operation and activities.
- This license is not transferable to any company/other party.
- This license will be voided if the company is found to be in the process of liquidation, winding-up or dissolution.
- Company shall inform PETRONAS on any changes related to company's position such as equity ownership, board of directors and management staff within fourteen (14) days. Failure to do so may result in revocation of License.
- Company should take immediate action to adhere to the special conditions imposed as stated in the appendix of the PETRONAS license certificate and to inform PETRONAS on the progress of the action.
- Company is not allowed to take another company as principal, agent, sub-contractor or otherwise to provide any service or supply of any facility, fittings or equipment on its behalf without prior written consent from PETRONAS.
- Company shall allow PETRONAS representatives for inspection visit / site / company audit and receive / copy of documents and interviewing employees and related parties.
- Sub-contract work to another contractor without written permission from PETRONAS.
- Repeat any contract or tender awarded.
- Entering or accepting contract or tender during the license suspension period.
- Provide false, inaccurate or misleading information.
- Does not follow tender's regulations and others including but not only limited to sending pre-qualification letters, bidding or bidding.
- Engaged in any inappropriate activities with this License.
- According to Act 9, Petroleum Act 1974, a person who initiates or continues any business or continues providing services as mentioned in Act 7 without a license or do not comply with any conditions of the license is committing a crime and can be fined not exceeding RM20,000.00 (Twenty Thousand Ringgit) or imprisonment for a period not more than two (2) years or both and in respect of each continuous crime, it is subject to further fine of RM2,000.00 (Two Thousand Ringgit) for every one (1) day or any part of one (1) day which the offence continues after the first conviction is recorded.
- This approval is not an agreement/guarantee that your company will be called to participate in a tender or quotation of PETRONAS or its subsidiaries.

PETRONAS LICENSE

ONE INDUSTRY ALL SOLUTION



POLYGON SYNERGY VENTURES



POLYGON SYNERGY
VENTURES

CONTACT US



+6016-306 4789 (M. Riduan Ahmad)



www.psvglobal.com



sales@psvglobal.com



my.linkedin.com/company/psvglobal



Polygon Synergy Ventures



Visit Our Website

Website: psvglobal.com





THANK YOU



**POLYGON SYNERGY
VENTURES**



Visit Our Website
Website: psvglobal.com